

ALUMIL
-
ALUMINIUM HANDLES



www.alumil.com

The logo for ALUMIL, featuring the word "ALUMIL" in a bold, yellow, sans-serif font. The letter "A" is stylized with a diagonal slash through it. The background is a dark gray gradient with a black triangular shape in the top right corner.

DESIGN HANDLES

www.alumil.com

page

10-19

1

**STANDARD
WINDOW
HANDLES**

**STANDARD
FENSTERGRIFFE**

- EX-38090725
- EX-38090738
- EX-38092738

- EX-38000976

- EX-38091738
- EX-38093738

- EX-38018147
- EX-38028147

- EX-38095738
- EX-38096738

- EX-38097738
- EX-38098738

- EX-38080719

page

20-23

2

**CREMONE
HANDLES**

**CREMONE
DREHFENSTERGRIFFE**

- EX-38080715
- EX-38080716
- EX-38080717

page

24-31

3

**STANDARD
ENTRANCE
DOOR
HANDLES**

**STANDARD
TÜRDRÜCKER**

- EX-38097610

- EX-38097880
- EX-38097881

- EX-38097882

- EX-38097710

- EX-38098681

page

32-39

4

**SUPREME
HANDLES**

**SUPREME
GRIFFE**

- EX-4550221722

- EX-4550221822

- EX-4552210022
- EX-4552215022

- EX-4550222022
- EX-4550222122

- EX-4550013122

- EX-4552210822

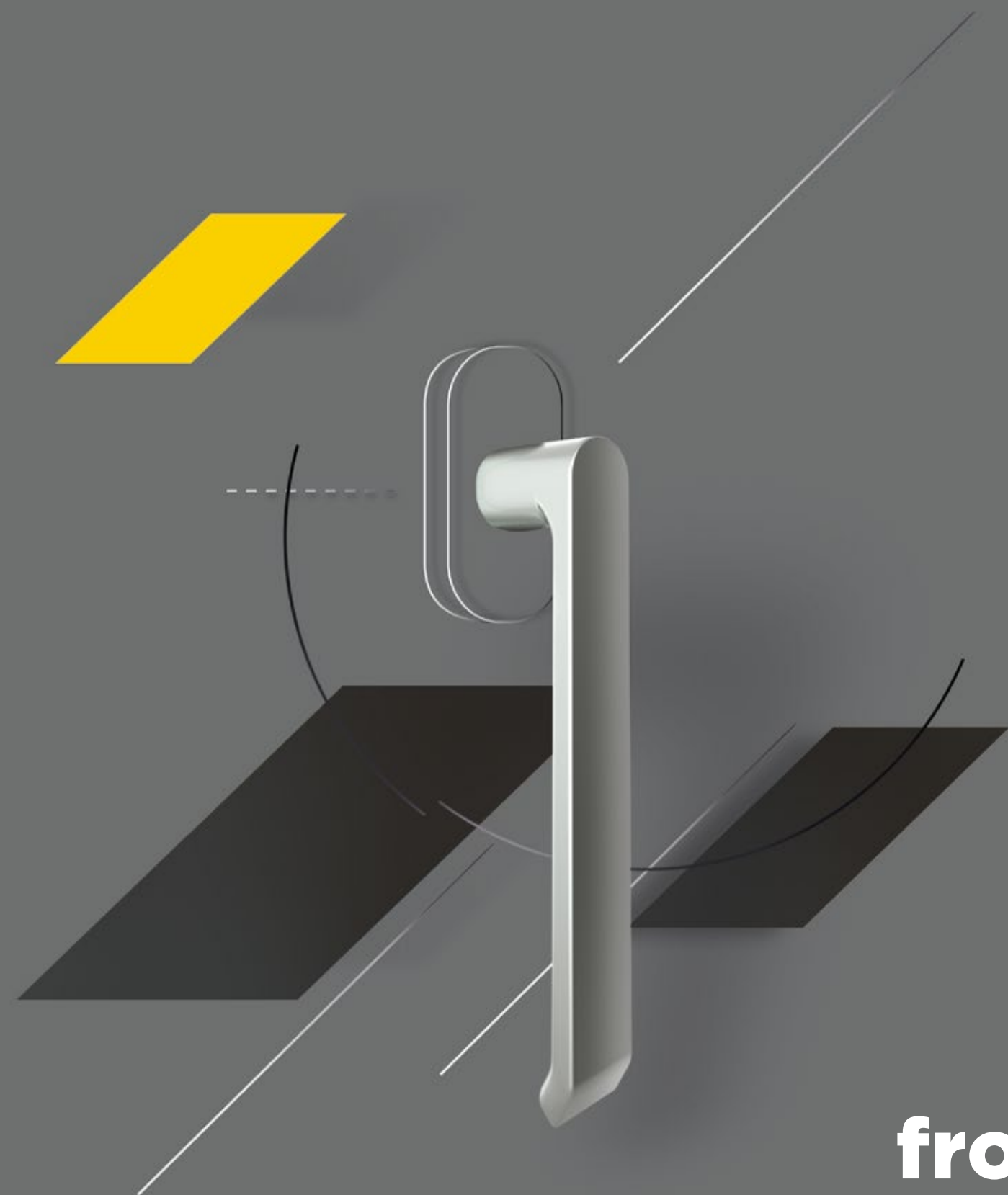

**from
concept
to creation**

EN

ALUMIL S.A. is the largest aluminium extrusion group in South East Europe, with 26 subsidiaries and an international sales network in more than 60 countries worldwide. Based on a long experience of 30 years, we offer architectural systems of top quality, as for example our world-class SUPREME series.

In accordance with ALUMIL high quality standards and along with our vast variety of accessories, our company provides you furthermore with a complete range of Branded Handles, which successfully cover all of your architectural and technical needs.

ALUMIL Handles main characteristics:

- straight minimal lines to offer a unique and a high aesthetic result
- handles of same design to cover all solutions in a uniform way
- ALUMIL logo and unique design to provide a distinctive identity of top quality
- close cooperation with world-class manufacturers to ensure flawless operation, guaranteed
- a “necessity” for ALUMIL outstanding SUPREME Systems

DE

ALUMIL S.A. ist die größte Unternehmensgruppe im Bereich Aluminiumextrusion in Südost Europa, mit 26 Tochtergesellschaften und ein weltweites Vertriebsnetz in mehr als 60 Ländern. Basierend auf einer 30jährigen Erfahrung, bietet unser Unternehmen Produkte mit top Qualität, wie zum Beispiel unsere sehr gehobene Produktserie “SUPREME”.

In Übereinstimmung mit ALUMIL’s hohen Qualitätsniveau und zusammen mit unserer breiten Auswahl an Zubehör, bieten wir Ihnen eine erstklassige Kollektion von gebrandmarkten Griffen, die erfolgreich alle Ihrer technischen und architektonischen Bedarfe befriedigen können.

Haupteigenschaften der “ALUMIL GRIFFE”:

- Gerade Linien mit minimalen Design, die ein hohes aesthetisches Ergebniss anbieten
- Konsistenz dank der gleichen Design-Logik für Griffen mit unterschiedlicher Funktionsweise
- “ALUMIL Logo” und einzigartiges Design, das Ihren Systemen eine distinktive Identität in top Qualität verleiht
- Kooperation mit Welt-Klasse Herstellern, so dass fehlerfreie Funktionalität geliefert und garantiert wird
- Ein “Muss” für die hochwertigen SUPREME Systeme von ALUMIL



**minimal design
with exceptional
aesthetic result**



**suitable for regular
as well as for more
special solutions**



**unique design
and branding for
unique system
identity**



**sophisticated design
with straight lines
and smooth curves**





STANDARD
WINDOW
HANDLES

STANDARD
FENSTERGRIFFE

**BEAUTY IN
SIMPLICITY**

**SCHÖNCHEIT
DURCH
EINFACHHEIT**



WINDOW HANDLE WITH SPINDLE

Window handle with ALUMIL unique design in minimal lines applicable to tilt & turn and sliding systems. A patented blocking mechanism **Secustik®** installed in its oval rosette provides integrated security and jams the handle if anyone tries to turn it from outside.

It comes with 38mm or 25mm spindle length and as a pair for in/out placement.

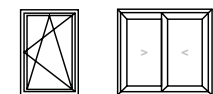

FENSTERGRIFF MIT VIERKANT

Fenstergriff mit 7mm Vierkant, entwickelt bei ALUMIL in minimalen Design, passend für Dreh- und Schiebefenster Systeme.

Der patentierte Blockiermechanismus, **Secustik®** der in den Ovalrosetten installiert ist, bietet größere Sicherheit in dem er den Griff blockiert, wenn jemand versucht ihn von außen zu drehen.

Erhältlich mit 38mm und 25mm langem Vierkant und als Paar (innen/außen)

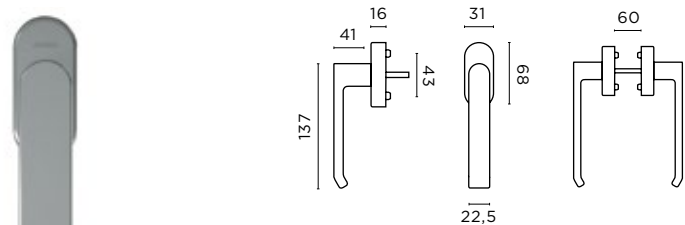

FULL METAL COVER HANDLE

Window handle of ALUMIL special design applicable to any tilt & turn and sliding systems. Under a full metal rosette cover, the patented blocking mechanism **Secustik®** provides integrated security and jams the handle if anyone tries to turn it from outside.

Available in standard and other powder coatings.

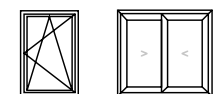

FENSTERGRIFF MIT VERDECKTEM GETRIEBE

Fenstergriff mit 7mm Vierkant, entwickelt bei ALUMIL, passend für alle Dreh - und Schiebefenster Systeme. Mit ovaler Rosette aus aluminium, die das ganze Secustik Sperr-getriebe deckt.

Erhältlich in allen Standard- aber auch in Sonderfarben.





LONG WINDOW HANDLE

Window handle with ALUMIL unique design with anti-burglar mechanism Secustik¹ and a much longer handle (127mm). It is perfectly applied to lift & slide systems of lighter constructions as well as to tilt & turn and sliding ones. It comes both as a single handle and as a pair for in/out use, and can be combined with a relevant flush handle (EX-38054203).

The single handle is available in all powder coatings.

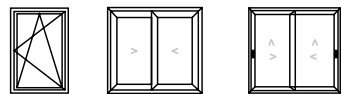

LANGER FENSTERGRIF F MIT VIERKANT

Fenstergriff größerer Länge (127mm) entwickelt bei ALUMIL. Passend für Grossformatige Drehfenster und leichte Schiebe und Hebeschiebe-Systeme. Mit Secustik Sperr-getriebe.

Erhältlich auch paarweise als Innen- und Außengriff oder passend dazu der Muschelgriff (EX-38054203)

Der einzel Griff ist erhältlich in allen Farben,



LIFT & SLIDE WINDOW HANDLE

ALUMIL design handle with 10mm spindle, for lift & slide systems both as a single and as a pair for in/out use.

The single handle may be accompanied with the corresponding flush which is available in two different depths, 7 and 11mm (EX-38054201, EX-38054202).

Available in powder coatings, the single, the pair and flushes.

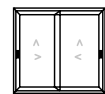

GRIF FÜR HEBE-SCHIEBETUREN

Griff mit 10mm Vierkant, für Hebe-Schiebesysteme, erhältlich auch paarweise als Innen- und Außengriff mit, oder ohne, äußeren Zylinder-öffnung.

Der Griff kann mit den Muschelgriffen EX-38054201 (Tiefe 7mm) und EX-38054202 (Tiefe 11mm) kombiniert werden.

Erhältlich in allen Standard- und Sonderfarben.

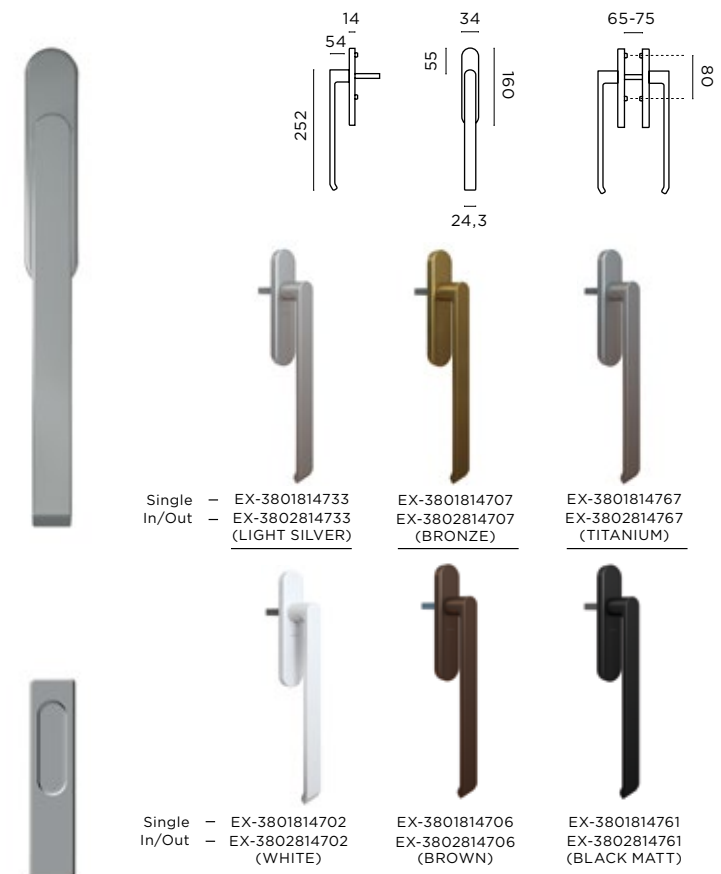



**CRANKED WINDOW HANDLE WITH SPINDLE
LEFT - RIGHT**

Cranked handle on oval rosette with patented blocking mechanism Secustik[®] for integrated security. Elegant and ideal for sliding and façade windows especially when little space available for handling (e.g. S350).

Available in right and left version.

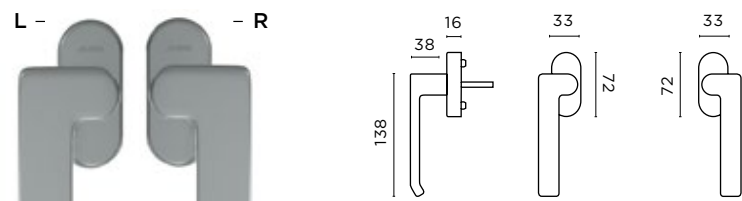
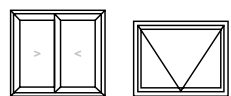

L - EX-3809573833
R - EX-3809673833 (LIGHT SILVER)
EX-3809573807
EX-3809673807 (BRONZE)
EX-3809573867
EX-3809673867 (TITANIUM)

L - EX-3809573802
R - EX-3809673802 (WHITE)
EX-3809573806
EX-3809673806 (BROWN)
EX-3809573861
EX-3809673861 (BLACK MATT)

**GEKRÖPFTER FENSTERGRIFF
MIT VIERKANT**

Griff in 'versetzter Form', mit Secustik Sperrgetriebe und ovaler Rosette, für integrierte Sicherheit. Ideal für Schiebe- und Ausstellfenster und überall dort wo Platzmangel für die Hände herrscht.

Erhältlich als Rechts- oder Linksgriff.

**CRANKED HANDLE WITHOUT ROSETTE AND
SPINDLE LEFT - RIGHT**

Cranked handle without rosette and without spindle applicable to façade windows when there is no adequate space for fixing.

The handle is of the same special Alumil design and available in right and left version.

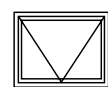

L - EX-3809773833
R - EX-3809873833 (LIGHT SILVER)
EX-3809773807
EX-3809873807 (BRONZE)
EX-3809773867
EX-3809873867 (TITANIUM)

L - EX-3809773802
R - EX-3809873802 (WHITE)
EX-3809773806
EX-3809873806 (BROWN)
EX-3809773861
EX-3809873861 (BLACK MATT)

**GRIFF MIT VERSETZTER GRIFFFLÄCHE OHNE
ROSETTE UND VIERKANT**

Griff in 'versetzter Form', mit Secustik Sperrgetriebe ohne Rosette und Vierkant. Ideal für Ausstellfenster, dort wo Platzmangel für die Hände herrscht.

Erhältlich als Rechts- oder Linksgriff.



**SPECIAL WINDOW HANDLE
WITHOUT ROSETTE**

An outstanding handle with ALUMIL special design, without rosette. Offers clear and minimal aesthetics as well as easy installation and assembly on the groove without any machining.

Available in all powder coatings.

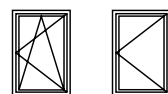
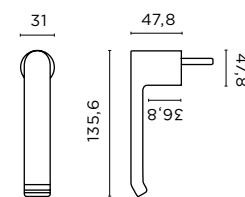

**FENSTERGRIFF
OHNE ROSETTE**

Fenstergriff ohne Rosette für Dreh -und Drehkippenfenster. Minimal Design mit sehr einfacher Montage. Erhältlich in allen RAL Farben.



EX-3808071902
(WHITE)



EX-3808071903
(BLACK)



EX-3808071909
(GREY)

Special transmission gears should be used:
4053951000 transmission gear for side-hung windows and 4053952000 gear, with accessories kit included, for tilt & turn ones.

Dazu werden folgende Spezialgetriebe angeboten:
4053951000 Getriebe für Dreh-Fenster und
4053952000 Getriebe, mit Zubehör Kit enthalten,
für Drehkippen-Fenster.



CREMONE
HANDLES

CREMONE
FENSTERGRIFFE

**STYLE YOU
CAN FEEL**

**STIL DEN
SIE FÜHLEN
KÖNNEN**



CREMONE HANDLE FOR SIDE-HUNG

Cremone handle with ALUMIL extraordinary design, for side-hung applications characterized for its straight lines, fully aligned with all of our branded handles.

Available in 3 standard colors as well as in all powder coatings.

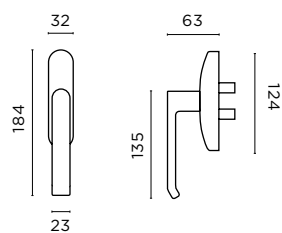

CREMONE HANDLE FOR TILT & TURN

Cremone with ALUMIL design for tilt & turn applications, compatible with either Giesse or GU hardware. Beautiful straight lines and in correspondence with all of our branded handles.

Available in 3 standard colors as well as in all powder coatings.

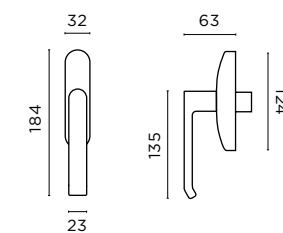

KREMONE GRIFF FÜR DREHFENSTER

Drehfenstergriff für Fenster ohne Kippfunktion. Im gleichen Design mit den anderen Alumilgriffen.

Erhältlich in 3 Standard Farben und nach Vereinbarung in allen RAL-Farben.



KREMONE GRIFF FÜR DREHFENSTER MIT KIPPFUNKTION

Drehfenstergriff für Fenster mit Kippfunktion (für Giesse und GU-Beschläge). Im gleichen Design mit den anderen Alumilgriffen.

Erhältlich in 3 Standard Farben und nach Vereinbarung in allen RAL-Farben.





**STANDARD
ENTRANCE
DOOR
HANDLES**

**STANDARD
GRIFFE
FÜR
EINGANGSTÜREN**

**ELEGANCE
AT FIRST
SIGHT**

**ELEGANZ
AUF DEN
ERSTEN
BLICK**



ENTRANCE DOOR HANDLE SET

Minimal entrance door set with separate narrow rosette and 8mm spindle.

In complete alignment with ALUMIL design and available in all powder coatings.

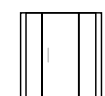
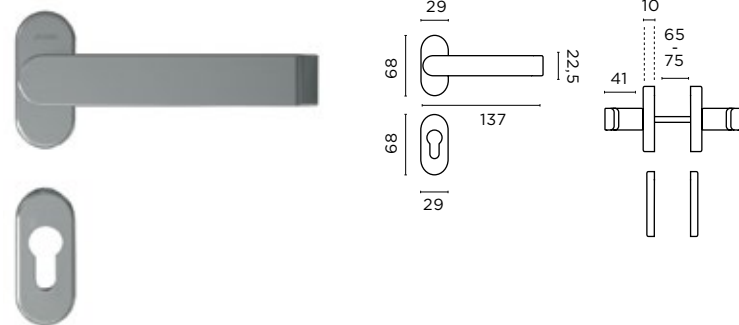

TÜRDRÜCKER SET MIT ROSETTE

Türdrücker Innen/Außen, mit 8mm Vierkant, minimal Design und flacher Rosette. In gleicher Form mit allen Alumilfenstergriffen. Erhältlich in allen Farben.



SPINDLE FOR WIDER SASHES

Longer spindles for wider sash applications, i.e. for M11500 and SD95

VIERKANTSTIFTE FÜR BREITERE PROFILE

Im Falle sehr breiter Profile sind Vierkantstifte mit entsprechender Länge erhältlich, z.B. für die Alumilsysteme M11500 und SD95.

EXPANSION SPINDLE FOR SINGLE HANDLE

When the handle is to be used only on one side, expansion spindles are available as well as additional escutcheons (EX-38022321).

VIERKANT FÜR EINSEITIGE TÜRDRÜCKER

Für einseitige Türdrücker sind die längeren Vierkantstifte und die dazupassende Rosetten als extras erhältlich (EX-38022321).

EX-3804682700
8x170mm M11500
-
EX-3804683500
8x190mm SD95

EX-3801853100
8x65mm
-
EX-3801855500
8x75mm
-
EX-3807196700
8x85mm



ENTRANCE DOOR HANDLE ON PLATE

Entrance door handle in elegant lines with 8mm spindle and unified plate. Special ALUMIL design and in compliance with all our branded handles.

It comes both as a pair and as a single handle. 85mm handle - key hole distance.

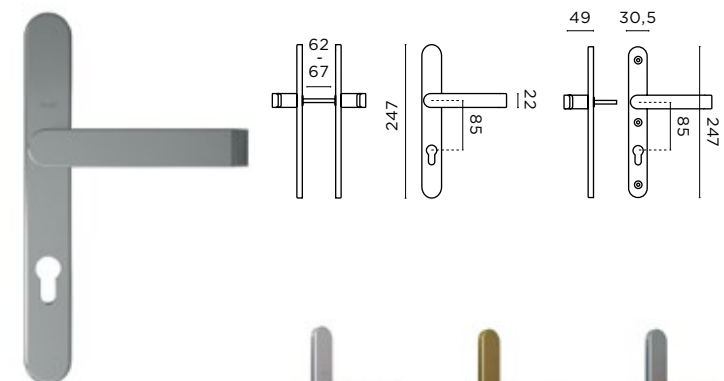

TÜRDRÜCKER MIT LANGSCHILDROSETTE

Türdrücker mit Langschildrosette, mit 8mm Vierkant und einen Zylinder/Vierkant Maß von 85mm. Design in Übereinstimmung mit allen ALUMIL's gebrandmarkten Griffen

Erhältlich auch allein, als einzel Türdrücker

ENTRANCE DOOR HANDLE WITH FIXED KNOB

Entrance door handle with 8mm spindle and stable knob on the outer side. ALUMIL design in full alignment with the whole range of our branded handles.

85mm handle-key hole distance

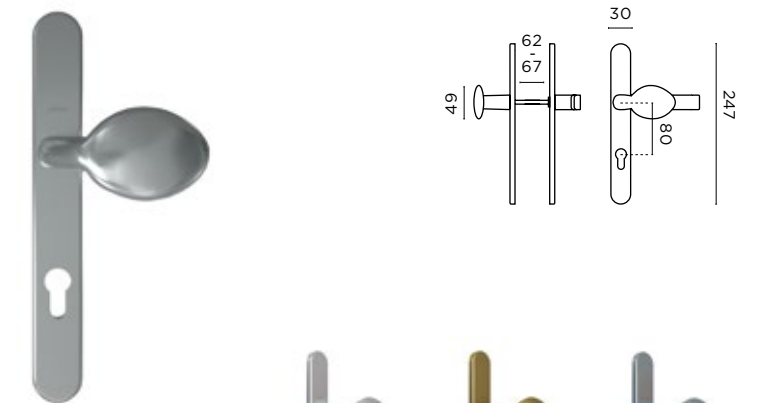

FESTER TÜRDRÜCKER

Türaußengriff mit 8mm Vierkant und mit festem Griff an der Aussenseite. Mit einen Zylinder/Vierkant Maß von 85mm.



CRANKED ENTRANCE DOOR HANDLE

Cranked entrance door handle suitable for outwards opening applications. Special design providing additional space for handling and in compliance with safety specifications.

It is offered as a single handle, with a separate ((EX-38097711)) escutcheon. Spindles in various lengths are available.

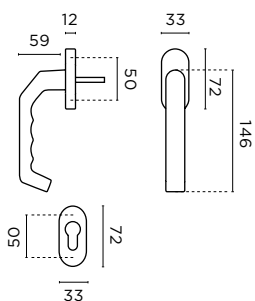

TÜRDRÜCKER MIT GEKRÖPFTEM GRIFF

Eingangstür Griff mit gekröpfter Form, ideal für auswärtsöffnende Türen. Spezielles Design das mehr Platz für die Hände bietet.

Erhältlich allein als einzel Griff, separate Rosette und Vierkant in verschiedenen Längen.



INTERIOR DOOR HANDLE SET

Interior door handle set with ALUMIL's elegantly simple Design, ideal for INTERNO's modern door solutions.

With round rosette and escutcheon, in alignment with the complete range of our branded handles.

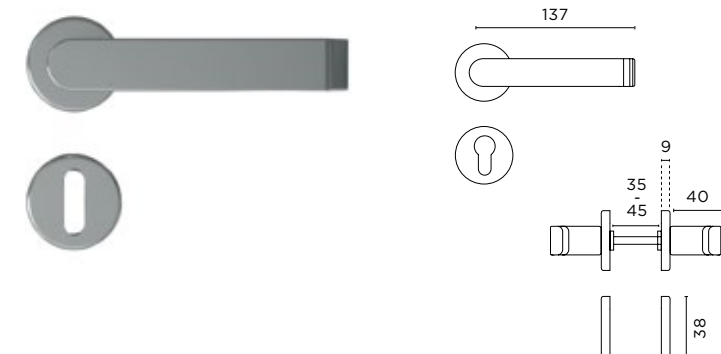

INNENTÜRDRÜCKER PAAR

Innentürdrücker Set mit ALUMIL's eleganten Design, ideal für INTERNO's modernen Tür Lösungen.

Erhältlich auch mit runder Rosette und Escutcheon, in Übereinstimmung mit allen unserer gebrandmarkten Griffen.





SUPREME
HANDLES

SUPREME
GRIFFE

AN
ESSENCE OF
EXCELLENCE

EINE
ESSENZ VON
PERFEKTION



WINDOW HANDLE WITH SPINDLE

Elegant window handle with sharp straight lines made of solid brass material in chrome matt finishing. Ideal for ALUMIL SUPREME series, providing an overall excellent aesthetic result.

Set with an oval rosette, applicable to hinged and sliding systems.

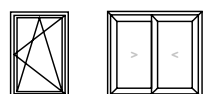
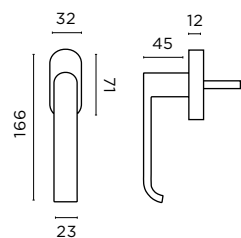

WINDOW HANDLE WITH NARROW ROSETTE

Elegant window handle on an attractively thin rosette of 6mm height. In compliance with current architectural trends and applicable to most of our systems.

Made of solid brass material in chrome matt finishing.

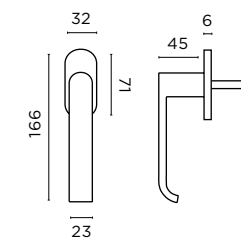

FENSTERGRIFF MIT VIERKANT

Eleganter Fenstergriff mit Vierkant, gerade Linien in Edelstahl matt Finish. Ideal für ALUMIL's SUPREME Serien, da ein hoch modernes Ergebnis geboten wird.

Set mit ovaler Rosette, anwendbar sowohl auf Dreh-Kipp als auch auf Schiebefenster.



EX-4550221722
(CHROME MATT)

FENSTERGRIFF MIT FLACHER ROSETTE

Besonders eleganter Fenstergriff, mit einer sehr flachen Rosette von 6mm. In völliger Übereinstimmung mit den aktuellen architektonischen Trends und anwendbar auf fast alle unserer Systeme.



EX-4550221822
(CHROME MATT)



ENTRANCE DOOR HANDEL WITH OVAL ROSETTE

Elegant entrance door handle in straight modern lines and with oval rosette. Made of solid brass material in chrome matt finishing, ideal for INTERNO high-end "ZEN" and "SMART" doors and perfectly combined with inox decorative elements.

Additional escucheons are available (EX-4551512822)

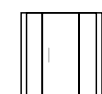
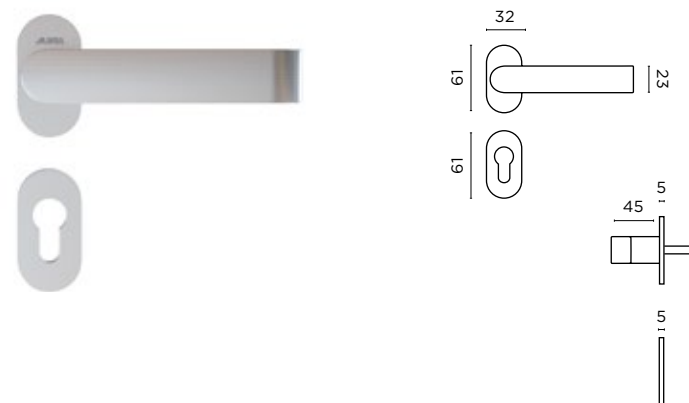

TÜRDRÜCKER MIT OVALER ROSETTE

Besonders eleganter Türdrücker in geraden Linien mit ovaler Rosette. Hergestellt aus Messing in matt Finish, ideal für INTERNO's hochwertige "ZEN" und "SMART" Türen und perfekt für Kombinationen mit Edelstahldekoration.



R - EX-4552210022
L - EX-4552215022
(CHROME MATT)

ENTRANCE DOOR HANDLE WITH SQUARE ROSETTE

Elegant entrance door handle on thin square rosette, ideal for INTERNO extravagant aluminium entrance doors "ZEN" and "SMART".

Made of solid brass material in chrome matt finishing to be combined with their inox decorative elements.

Additional escutcheons are available (e.g. EX-4551512822).

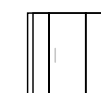
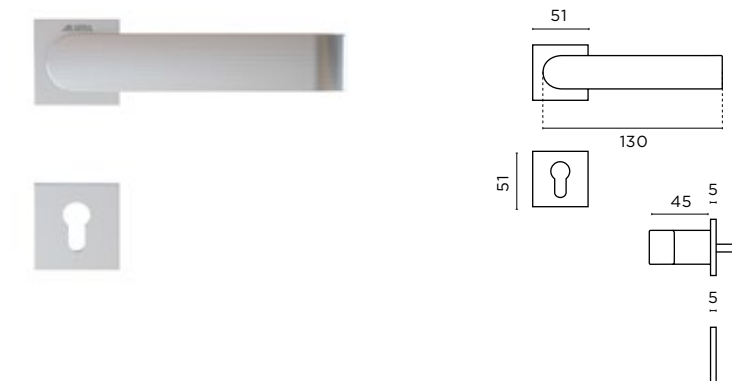

TÜRDRÜCKER MIT QUADRATISCHER ROSETTE

Eleganter Türdrücker mit quadratischer Rosette. Hergestellt aus Messing in matt Edelstahlfinish, ideal für die hochwertigen "ZEN" & "SMART" Türen, geeignet für spezielle Edelstahldekorationen.

Extra Rosette ist verfügbar (EX-4552512822).

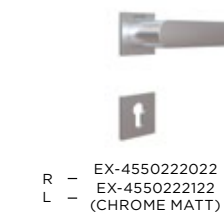

R - EX-4550222022
L - EX-4550222122
(CHROME MATT)



LIFT & SLIDE WINDOW HANDLE WITH FLUSH HANDLE

A very stylish lift & slide window handle serving as an ornament when placed on ALUMIL SUPREME series.

A sturdy handle made of solid brass material in chrome matt finishing and with a 10mm spindle. Combined with an equally elegant flush handle of 13mm depth.

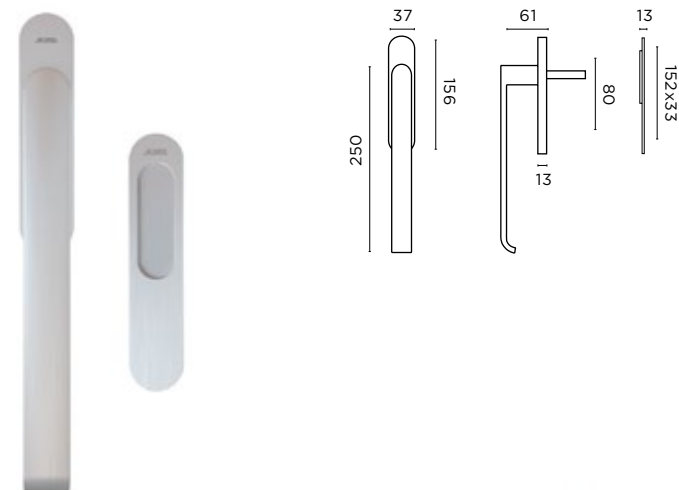
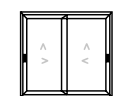

GRIF FÜR HEBE-SCHIEBETÜREN MIT MUSCHELGRIF

Ein sehr stilvoller Hebe-Schiebetür Griff, der den ALUMIL's SUPREME Serien noch mehr Stil hinzufügt.

Ein robuster Griff, hergestellt aus soliden Messing in matten Edelstahlfinish, mit einen 10mm langen Vierkant, geliefert zusammen mit einen 13mm tiefen Muschelgriff.



INTERIOR DOOR HANDLE PAIR

Interior door handle set with round rosette made of solid brass material in chrome matt finishing.

Ideal for all INTERNO doors to be combined with the various window handles of the same series.

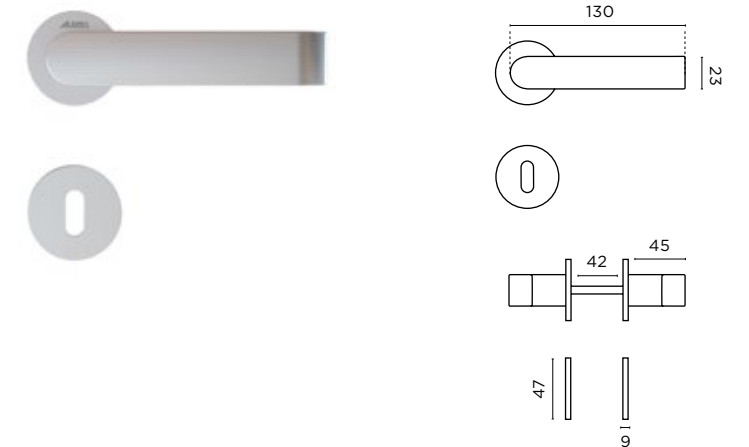

INNENTÜRDRÜCKER SET

Innentürdrücker mit runder Rosette, aus Messing in matten Edelstahlfinish.

Ideal für alle INTERNO Türen in Kombination mit verschiedenen Fenstergriffen der gleichen Serien.



**general
information**
/
**generale
Information**

GENERAL INFORMATION

EN

- The collection of handles with ALUMIL logo provides a distinctive identity to all of our systems. Moreover, the identical design logic of all our handles, provide uniformity and coherence to your space.
- ALUMIL cooperation with world-class manufacturers ensures that our handles are of excellent quality and flawless functionality, guaranteed by ALUMIL cooperation.
- Most of our standard window handles contain the **Secustik[®]** mechanism inside, a patented jamming-device which provides integrated security and blocks the handle if anyone tries to turn it from outside.
- Though the handle variety is very extensive, more are to come so that special solutions can be covered.
- The colour variety consists of specific standard colours depending on the handle model. Furthermore, if requested, all handles are available in all RAL-colours.
- In some cases there might be a right/left version, a single and in/out handle, and some differences in the spindle length. The above options differentiate the final code of the handle.
- In almost all cases a door handle comes with its rosettes, and separate rosettes are available if requested. Flushes are mainly provided with a separate code.

ALLGEMEINE INFORMATION

DE

- Indem Sie die namenhafte Drücker von Alumil wählen, geben Sie ihre Konstruktionen Bekanntheit. Ob Tür oder Fenster die Griffe haben immer das gleiche Aussehen.
- Alumil arbeitet mit international anerkannten Unternehmen und bietet neben der hohen Qualität und Funktionalität, auch Garantie.
- Alle Drücker sind mit dem patentierten Secustik[®]- Sperrgetriebe ausgestattet, dass die Sicherheit Ihrer Tür erhöht
- Das Spektrum der Markendrücker ist besonders breit und wird immer grösser mehr Griffe für spezielle Lösungen dazukommen
- Die Farben Auswahl besteht aus spezifischen Standardfarben je nach Griff/Drücker Model. Weitere Pulverfarben sind nach Vereinbarung möglich.
- In dieser Brochüre werden Sie Griffe mit unterschiedlichen Art. Nr. finden, die im ersten Blick gleich aussehen. Es handelt sich um Rechts/Links, einzeln oder Set, innen/ außen oder um Griffe mit unterschiedlicher Vierkantlänge.
- In den meisten Fällen, bei Türengriffe sind die Rosetten dabei. Wenn mehr Rosetten verlangt werden sind sie als extra erhältlich. Die Muschelgriffe sind meistens mit extra Art. Nr. erhältlich.

BRANDED HANDLES IN ALL POWDER COATINGS

EN

MARKENDRÜCKER IN ALLEN PULVERBESCHICHTUNGSFARBEN

DE

ALUMIL branded handles are available in various standard colors, as presented; some of these handles however, may also be available in all powder coatings (customer selection).

In this case, handles and aluminium profiles are treated in our facilities and consequently they are offered in the same finishing.

** Some standard colored handles may be under make-to-order terms.*

Die namenhafte ALUMIL Tür - und Fensterdrücker sind erhältlich in verschiedenen Standardfarben wie dargestellt.











Einige dieser Handgriffe jedoch, die gebräuchlichsten, können auch in allen Pulverbeschichtungsfarben erhalten werden (nach Kundenwunsch). In diesem Fall werden die Griffe und Aluminiumprofile in unseren Einrichtungen behandelt und folglich haben sie die gleiche Farbentönung.





** Allgemein sind die Griffe in Standard Farben erhältlich. Einige Standardfarbenkombinationen können "Make-to-Order" sein.*

	EX-38000976	Window Handle Full Metal Vollmetall Fenstergriff		EX-38080719	Special Handle Without Rosette Spezial Fenstergriff Ohne Rosette
	EX-38091738	Long Window Handle (Full Metal) Lang Fenstergriff (Vollmetall)		EX-38080715	Cremone Handle For Side-Hung Cremonegriff Für Drehfenster
	EX-38054203	Flush Handle 43mm Muschelgriff 43mm		EX-38080716	Tilt & Turn Cremone Handle Cremonegriff Für Dreh-Kippfenster
	EX-38018147	L&S Window Handle Hebe-Schiebeturen Griff		EX-38080717	Tilt & Turn Cremone Handle Cremonegriff Für Dreh-Kippfenster
	EX-38028147	In/Out L&S Window Handle Paar Hebe-Schiebeturen Griff		EX-38097610	Door Handle With Rosette Türdrücker Mit Rosette
	EX-38054201	L&S Flush Handle Muschelgriff		EX-38022321	EX-38097610 Rosette Rosette Für EX-38097610
	EX-38054202	L&S Flush Handle Muschelgriff			



code list
/
code liste

STANDARD WINDOW HANDLES









	CODE	DESCRIPTION	APPLICATION	CHARACTERISTICS	FINISHING	PAGE
Window Handles with Spindle						
Fenstergriffe Mit Vierkant						
	EX-38090725	Window Handle With Spindle Fenstergriff Mit Vierkant	Hinged - Tilt & Turn Slide	Spindle 7/25mm Vierkant 7/25mm	6	12
	EX-38090738	Window Handle With Spindle Fenstergriff Mit Vierkant	Hinged - Tilt & Turn Slide	Spindle 7/38mm Vierkant 7/38mm	6	12
	EX-38092738	In/Out Window Handle Set Paar Innen-Außengriff	Hinged - Tilt & Turn Slide	In/Out, Spindle 7/60mm Paar, Vierkant 7/60mm	6	12
Full Metal Cover Handle						
Fenstergriff Mit Verdecktem Getriebe						
	EX-38000976	Window Handle With Spindle Vollmetall Fenstergriff mit Vierkant	Hinged - Tilt & Turn Slide	Full Metal Cover, Spindle 7mm Vollmetall, Vierkant 7mm	6+	13
Long Window Handles						
Lange Fenstergriffe						
	EX-38091738	Long Window Handle Lang Fenstergriff Mit Vierkant	Hinged - Tilt & Turn Slide - Lift & Slide	177mm Length, Spindle 7mm 177mm Lange, Vierkant 7mm	6+	14
	EX-38093738	Double Window Handle With Spindle Paar Lang Fenstergriff Mit Vierkant	Hinged - Tilt & Turn Slide - Lift & Slide	In/Out, 177mm Length, Spindle 7/60mm Paar, 177mm Lange, Vierkant 7/60mm	6	14
	EX-38054203	Flush Handle Muschelgriff	Slide - Lift & Slide	43mm, 90Kg	6+	14
Lift & Slide Window Handles and Flushes						
Hebe-Schiebenturengriff und Muschelgriffen						
	EX-38018147	L&S Window Handle Hebe-Schiebeturen Griff	Lift & Slide	Spindle 10mm, 80mm 10mm Vierkant, 80mm	6+	15
	EX-38028147	In/Out L&S Window Handle Paar Hebe-Schiebeturen Griff	Lift & Slide	Cylinder Hole, Spindle 10/65-75mm Zylinder, Vierkant 10/65-75mm	6+	15
	EX-38054201	Flush Handle Muschelgriff	Lift & Slide	7mm Depth, 80mm 7mm Tiefe, 80mm	6+	15
	EX-38054202	Flush Handle Muschelgriff	Lift & Slide	11mm Depth, 80mm 11mm Tiefe, 80mm	6+	15

	CODE	DESCRIPTION	APPLICATION	CHARACTERISTICS	FINISHING	PAGE
Crank Window Handles						
Fenstergriffe Mit Versetzter Grifffläche 	EX-38095738	Cranked Window Handle ?	Top Hung - Slide	Left, Spindle 7/38mm Links, 7/38mm Vierkant	6	16
	EX-38096738	Cranked window handle ?	Top Hung - Slide	Right, Spindle 7/38mm Rechts, 7/38mm Vierkant	6	16
Crank Window Handles Without Rosette						
Fenstergriffe Mit Versetzter Grifffläche Ohne Rosette 	EX-38097738	Cranked Window Handle Without Rosette Mit Versetzter Grifffläche Ohne Rosette	Top Hung	Left, No Spindle Links, Ohne Vierkant	6	17
	EX-38098738	Cranked Window Handle Without Rosette Mit Versetzter Grifffläche Ohne Rosette	Top Hung	Right, no spindle Rechts, ohne Vierkant	6	17
Special Window Handle Without Rosette						
Spezial Griff Für Drehkipfenster Ohne Rosette 	EX-38080719	Special Handle Without Rosette Spezial Fenstergriff Ohne Rosette	Side-Hung Tilt & Turn	Without Rosette, Special Transmission Gear Ohne Rosette, Spezial Getriebe	3+	18

CREMONE HANDLES

	CODE	DESCRIPTION	APPLICATION	CHARACTERISTICS	FINISHING	PAGE
Cremone Handle For Hinged						
Cremone Fenstergriffe 	EX-38080715	Cremone Handle For Side-Hung Cremonegriff Für Drehfenster	Side-Hung	-	3+	22
	EX-38080716	Tilt & Turn Cremone Handle Cremonegriff Für Dreh-Kipfenster	Tilt & Turn	Giesse Hardware Giesse Beschlag	3+	23
	EX-38080717	Tilt & Turn Cremone Handle Cremonegriff Für Dreh-Kipfenster	Tilt & Turn	GU hardware GU Beschlag	3+	23

DOOR HANDLES

	CODE	DESCRIPTION	APPLICATION	CHARACTERISTICS	FINISHING	PAGE
Entrance Door Handle						
Türdrücker Mit Rosette						
	EX-38097610	Door Handle With Separate Rosette Türdrücker Mit	Entrance Door	In/Out, Spindle 8/65-75mm Innen-Aussen, Vierkant 8/65-75mm	6+	26
	EX-38022321	EX-38097610 Rosette Rosette Für EX-38097610	Entrance Door	29x68mm	6+	26
Entrance Door Handle On Plate						
Türdrücker Mit Langschildrosette						
	EX-38097880	Door Handle On Backplate Türdrücker Mit Langschild	Entrance Door	In/Out, Spindle 8/62-67mm Paar, Vierkant 8mm	6	28
	EX-38097881	Door Handle On Backplate Türdrücker Mit Langschild	Entrance Door	Single, Spindle 8mm Einzel, Vierkant 8mm	6	28
Entrance Door Handle With Fixed Knob						
Türdrücker Festem Griff An Der Aussenseite						
	EX-38097882	Door Handle With Fixed Knob Türdrücker Mit	Entrance Door	In/Out, Spindle 8/62-67mm Innen-Aussen, Vierkant 8/62-67mm	6	29
Cranked Entrance Door Handle						
Türdrücker Mit Gekröpftem Griff						
	EX-38097710	Cranked Door Handle Gekröpfter Türdrücker	Entrance Door	Single, cranked, spindle 8mm Einzel, gekröpfter, Vierkant 8mm	6	30
	EX-38097711	EX-38097710 rosette Rosette Für EX-38097710	Entrance Door	33x72mm	6	30
Interior Door Handle						
Innentürdrücker						
	EX-38098680	Interior Door Handle Innentürdrücker Paar	Interior	In/Out, Spindle 8mm Innen-Aussen, Vierkant 8mm	6	31

OLIVARI SUPREME HANDLES

	CODE	DESCRIPTION	APPLICATION	CHARACTERISTICS	FINISHING	PAGE
Window Handle With Spindle						
Fenstergriff Mit Vierkant		EX-4550221722	Window Handle With Spindle Fenstergriff mit Vierkant	Tilt & Turn, Slide	Spindle 7mm, Brass Vierkant 7mm, Messing	1 34
Window Handle With Low Rosette						
Fenstergriff Mit Dünnerer Rosette		EX-4550221822	Window Handle With Low Rosette Fenstergriff Mit Dünnerer Rosette	Tilt & Turn, Slide	Spindle 7mm, low rosette, Brass Vierkant 7mm, Messing, Rosette 6mm	1 35
Entrance Door Handle Oval						
Türdrücker Mit Ovaler Rosette		EX-4552210022	Door Handle Oval Right Türdrücker Mit Ovaler Rosette, Rechts	Entrance Door	Spindle 8mm, Brass, Messing, Vierkant 8mm, Rechts	1 36
		EX-4552215022	Door Handle Oval Left Türdrücker Mit Ovaler, Links	Entrance Door	Spindle 8mm, Brass, Messing Vierkant 8mm, Links	1 36
Entrance Door Handle Square						
Türdrücker Mit Eckiger Rosette		EX-4550222022	Door Handle Square Right Türdrücker Mit Eckiger Rosette, Rechts	Entrance Door	Spindle 8mm, Brass, Messing Vierkant 8mm, Rechts	1 37
		EX-4550222122	Door Handle Square Left Türdrücker Mit Eckiger Rosette, Links	Entrance Door	Spindle 8mm, Brass, Messing, Vierkant 8mm, Links	1 37
Lift & Slide Window Handle With Flush						
Griff Für Hebe-Schiebetüren		EX-4550013122	L&S Handle With Flush Hebe-Schiebetüren Griff	Lift & Slide	Spindle 10mm, with 13mm flush, Brass Vierkant 10mm, Messing, mit 13mm Tiefe Muschelgriff	1 38
Interior Door Handle						
INNENTÜRDRÜCKER PAAR		EX-4552210822	Interior Door Handle Innentürdrücker Paar	Interior	Spindle 8mm, Brass, Innen-Aussen, Vierkant 8mm, Messing	1 39

ALUMIL S.A.**Head offices/Factory:****Kilkis Industrial Area**

GR 61100, Kilkis
Tel.: +30 23410 79300
Fax: +30 23410 71988

Thessaloniki offices**& showroom:**

8, Gogousi Str, GR 56429
Efkarpiia, Thessaloniki
Tel.: +30 2313 011000, +30 2310
692472
Fax: +30 2310 692473
info@alumil.com
www.alumil.com

Europe**ALUMIL ROM INDUSTRY S.A.**

Calea Rahovei, nr.286A, sect.5
Bucuresti, Romania
Tel.: + 40 21 424 34 56/57/59
Fax: + 40 21 423 39 32
office@alumil.ro
www.alumil.ro

**ALUMIL INDUSTRY S.R.L.
(MOLDAVIA)**

Cetatea Bucuriei Street no.7
Chisinau, Moldova
Tel.: +37 322 59 52 17
Fax: +37 322 58 25 42
office@alumil.ro

ALUMIL UKRAINE LTD.

77-a, Vladimirska Str.
PC 01033, Kiev, Ukraine
Tel/Fax: +3 044 377 73 57
office@alumil.ua
pro@alumil.ua

ALUMIL HUNGARY K.T.F.

2040 Budars, Gyar utca 2,
Hungary
Tel.: +36 23428498
Fax: +36 234330284
E-mail: info@alumil.hu

ALUMIL CYPRUS

Pentagias 19
Industrial Area Idaliou
Nicosia, Cyprus
Tel.: 00 357 22461156
Fax: 00 357 22610021
a.gavrielides@alumil.com

ALUMIL YU INDUSTRY A.D.

Industrijska zona bb
23330 Nova Pazova, Serbia
Tel.: +382 0 22 321 302
Fax: +382 0 22 321 244
alumilyuindustry@alumil.com

ALUMIL BULGARIA LTD.

5 Iliia Beshkov str.
1528 Sofia, Bulgaria
Tel.: +359 2 979 00 22
Fax: +359 2 979 05 65
officebg@alumil.com
www.alumil.bg

ALUMIL ITALIA S.R.L.

Viale del Lavoro 3
37040 Arcole (VR), Italy
Tel.: +39 045 6144411
Fax: +39 045 6144405
info@alumil-italia.com

ALUMIL VARNA LTD.

West Industrial Zone 9009
Varna, Bulgaria
Tel.: +359 52 50 36 36
Fax: +359 52 50 56 63
varna_alumil@abv.bg

ALPRO

Production
Njegoseva bb
75440 Vlasenica, Bosnia and
Herzegovina
Tel.: +387 56 733 720
Fax: +387 56 733 196
office@alpro-vl.com
www.alpro-vl.com

BH ALUMINIUM

Trade
Njegoseva bb
75440 Vlasenica, Bosnia and
Herzegovina
Tel.: +387 56 733 720
Fax: +387 56 733 196
info@alumil.ba
www.alumil.ba

ALUMIL MONTENEGRO D.O.O

Mahala bb, 20000 Podgorica
Tel.: +382 0 20 872 104
Fax: +382 0 20 872 104
alumil.cg@t-com.me

ALUMIL KOSOVO SHPK

Rruga: Prishtinë-Fushë Kosovë
Tel.: +381(0)38 601 185
Fax: +381(0)38 601 186
info.ks@alumil.com

ALUMIL ALBANIA

High - Way
Tirana - Durres 7, Albania
Tel.: +355 47 800 230
Fax: +355 48 300 234
info.al@alumil.com

ALUMIL SKOPJE D.O.O

Bul. Promajska br. 74A 1000
Skopje, Fyrom
Tel.: +389 2 2466 200
Fax: +389 2 24 66 200
info.skopje@alumil.com

ALUMIL DEUTSCHLAND GMBH

Wingert Str. 21
D-64354 Reinheim
Tel.: +49 6162 9688770
Fax: +49 6162 9688775
info@alumil.de
www.alumil.de

ALUMIL FRANCE

104, Rue d' Aubagne
13006 Marseille, France
Tel.: +33 603995014
Fax: +33 491331118
a.anastay@alumil.com

ALUMIL YUG (RUSSIA)

2-e otdelenie
Agrofirma «Solnechnaya» 3/1
Krasnodar, 350012 Russia
Tel.: +7 861 2002685
Tel./fax: +7 861 2002686
info.yug@alumil.com

ALUMIL ZAGREB D.O.O

Brezovec Zelinski 5d
HR-10382 Donja Zelina, Croatia
Tel.: +385 (1) 66 07 610
Fax: +385 (1) 66 07 721
info@alumil-zagreb.hr

North America**ALUMIL N.A.**

4401 21st Street, Suite 203
Long Island City, NY 11101, USA
Tel.: +1 718 355 9393
Fax: +1 718 786 9393
info@alumilna.com

Southwestern Asia**ALUMIL MIDDLE EAST**

Mazaya Business Avenue BB1
29th Floor, Office # 2907
Jumeirah Lake Towers Dubai,
UAE
Tel.: +971 4 4425930, Fax: +971 4
4416528
sales.uae@alumil.com
marketing.uae@alumil.com
www.alumil.ae

ALUMIL TURKEY

Sahrayı Cedid Mah.
Halk Sok. No 27
Golden Plaza
A Blok Kat 1, Da.1
Kozyatağı - Istanbul
Tel.: +90 216 3024182-83
info.tr@alumil.com

Asia**ALUMIL SYSTEMS INDIA
PVT. LTD**

Office 1402, The Corporate Park
Plot No. 14 & 15, Sector 18
Vashi, Navi Mumbai 400 703,
India
Mob: +91 77388 95595
Tel.: +91 22 6564 5595
h.vengateri@alumil.com

Africa**ALUMIL MISR (EGYPT)**

14 Tawakoi Str. (ex Khaled Morad)
Jisr el Suez Industrial Area
Cairo, Egypt
Tel.: +20 226983542
Fax: +20 226983542
info.eg@alumil.com

ALUMIL ANGOLA

Rua N'Agola Kiluange - Complexo
Industrial FVK - Pavilhão 3,
Luanda
Tel.: +244940 191 085
comercial@alumil.co.ao

ALUMIL KENYA LTD

Alizeti Crescent, Road A
Off enterprise Road
Industrial Area
P.O. Box 42415 - 00100
Nairobi, Kenya
Tel.: +254 716 164604, +254 771
592724
info.kenya@alumil.com

ALUMIL
ALUMINIUM SYSTEM
HANDLES

www.alumil.com